

Applications:

Conduit outlet bodies are installed in conduit systems to:

- Act as pull outlets for conductors being installed
- Provide openings for making splices and taps in conductors
- Connect conduit sections
- Provide taps for branch conduit runs
- Make 90° bends in conduit runs
- Provide for access to conductors for maintenance and future system changes

Features:

Conduit Outlet Bodies

- Form 7 Condulet outlet bodies approach conduit in size for neat, compact installations
- Form 8 and Mark 9 bodies provide more room for heavier conductors
- Many shapes and sizes are available for rigid threaded conduit – for complete listings see pages 6–12
- Conduit hubs have tapered threads and feature integral bushings for protection of wire insulation
- Form 7 has exclusive snaptight and wedgenut cover attachment to provide clear, unobstructed cover opening
- Built-in rollers on all Form 5 1¼" to 4" C and LB bodies to facilitate wire pulling
- Series 5 bodies available in optional configuration with set screws on hubs for EMT conduit (add suffix -MT to catalog number)

Gaskets

Solid gaskets:

- Are used with blank covers
- For Mark 9 and Form 5, can be converted to open type gaskets by tearing out center section along scored lines – ½" to 2" sizes
- For Form 7 are used with all covers

Open gaskets:

- For Form 8 – ½" to 4" sizes
- For Mark 9 – 2½" to 4" sizes

Blank Covers

Stainless steel cover screws are standard on Form 7, Form 8, Mark 9, Series 5 and Form 5 covers.

• Form 7

Wedge nut design facilitates installation and removal. Nuts are held captive in cover. Covers can be used with or without gaskets. SNAPTIGHT™ Form 7 Covers with integral sealing gaskets are installed without the use of screws, reducing installation time and costs. Covers are reusable.

• Form 8

Two cover screws provided on all sizes to provide tight cover and gasket assembly. *Feraloy* iron alloy covers have dome shapes for added strength and extra wiring room.

• Mark 9

Self-retaining cover screws.

Certifications and Compliances:

Outlet Bodies –

- UL Standard: 514B
- Fed. Spec.: W-C-586D
- CSA Standard 22.2 No. 18
- NEMA 3R Raintight (when installed with cover and gasket)

Standard Materials:

- Form 7, Form 8 outlet bodies – *Feraloy* iron alloy
- Mark 9 outlet bodies – copper-free aluminum
- Form 5 – malleable iron
- Series 5 – die cast aluminum

Standard Finishes:

- Form 7, Form 8 outlet bodies – electrogalvanized with aluminum acrylic paint
- Mark 9 outlet bodies – natural
- Form 5 – electrogalvanized with aluminum acrylic paint
- Series 5 – aluminum acrylic paint

Options:

Description

Suffix

Form 7 body and cover only:

Copper-free aluminum	SA
<i>Corro-free</i> ™ epoxy powder coat - external body only	S752
<i>Corro-free</i> ™ epoxy powder coat - internal and external	S753
Series 5 in an EMT version with set screws on all hubs	MT
Series 5 pre-packaged with neoprene gasket and cover	CGN



Form 7



Mark 9



Form 8



Mogul











Condulet® Conduit Bodies - Cast Iron or Aluminum

1F

Dimensions Pgs. See pages 10–12 (Dimensions for Form 5 – see Section CP)

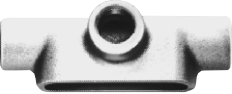
1F

Threaded Rigid Bodies

Shape	Style	Hub Size										
		1/2	3/4	1	1 1/4	1 1/2	2	2 1/2	3	3 1/2	4	
	C											
	Form 7	C17	C27	C37	C47	C57	C67	C77	C87			
	Form 8	C18	C28	C38	C448	C58	C68	C78	C88			
	Mark 9	C19	C29	C39	C49	C59	C69	C789	C889	C989	C1089	
	Form 5	C50M	C75M	C100M	C125M*	C150M*	C200M*	C250M*	C300M*	C350M*	C400M*	
Series 5	C15	C25	C35	C45	C55	C65	C75	C85	C95*	C105*		
	E											
	Form 7	E17	E27	E37								
	L											
	Form 7	L17	L27	L37	L47	L57	L67					
Double faced – may be used as LL or LR – has 2 openings, one of which is furnished with a blank sheet steel cover												
	LB											
	Form 7	LB17	LB27	LB37	LB47	LB57	LB67	LB777	LB87	LB97	LB107	
	Form 8	LB18	LB28	LB38	LB448	LB58	LB68	LB78	LB888	LB98	LB108	
	Mark 9	LB19	LB29	LB39	LB49	LB59	LB69	LB789	LB889	LB989	LB1089	
	Form 5	LB50M	LB75M	LB100M	LB125M*	LB150M*	LB200M*	LB250M*	LB300M*	LB350M*	LB400M*	
Series 5	LB15	LB25	LB35	LB45	LB55	LB65	LB75	LB85	LB95	LB105		
	LL											
	Form 7	LL17	LL27	LL37	LL47	LL57	LL67	LL777	LL87	LL97	LL107	
	Form 8	LL18	LL28	LL38	LL448	LL58	LL68	LL78	LL888	LL98	LL108	
	Mark 9	LL19	LL29	LL39	LL49	LL59	LL69	LL789	LL889	LL989	LL1089	
	Form 5	LL50M	LL75M	LL100M	LL125M	LL150M	LL200M	LL250M	LL300M	LL350M	LL400M	
Series 5	LL15	LL25	LL35	LL45	LL55	LL65	LL75	LL85	LL95	LL105		
	LR											
	Form 7	LR17	LR27	LR37	LR47	LR57	LR67	LR777	LR87	LR97	LR107	
	Form 8	LR18	LR28	LR38	LR448	LR58	LR68	LR78	LR888	LR98	LR108	
	Mark 9	LR19	LR29	LR39	LR49	LR59	LR69	LR789	LR889	LR989	LR1089	
	Form 5	LR50M	LR75M	LR100M	LR125M	LR150M	LR200M	LR250M	LR300M	LR350M	LR400M	
Series 5	LR15	LR25	LR35	LR45	LR55	LR65	LR75	LR85	LR95	LR105		
	T											
	Form 7	T17	T27	T37	T47	T57	T67	T77	T87	T97	T107	
	Form 8	T18	T28	T38	T448	T58	T68	T78	T88	T98	T108	
	Mark 9	T19	T29	T39	T49	T59	T69	T789	T889	T989	T1089	
	Form 5	T50M	T75M	T100M	T125M	T150M	T200M	T250M	T300M	T350M	T400M	
Series 5	T15	T25	T35	T45	T55	T65	T75	T85	T95*	T105*		
	TA											
	Form 7	TA17	TA27	TA37	TA47	TA57	TA67					
	TB											
	Form 7	TB17	TB27	TB37	TB47	TB57	TB67					
	Form 8	TB18	TB28	TB38	TB448	TB58	TB68					
	Mark 9	TB19	TB29	TB39	TB49	TB59	TB69					
	Series 5	TB15	TB25	TB35	TB45	TB55	TB65					
Form 5	TB50M	TB75M	TB100M	TB125M	TB150M	TB200M						
	X											
	Form 7	X17	X27	X37	X47	X57	X67					
	Form 8	X18	X28	X38	X448	X58	X68					
	Mark 9	X19	X29	X39	X45	X55	X65					
	Series 5	X15	X25	X35	X45	X55	X65					
Form 5	X50M	X75M	X100M	X125M	X150M	X200M						

* 1/2" - 4" Form 5 LB and C bodies are supplied with built-in rollers to facilitate wire pulling.

1F Condulet® Conduit Bodies - Cast Iron or Aluminum

Dimensions (In Inches)

1F

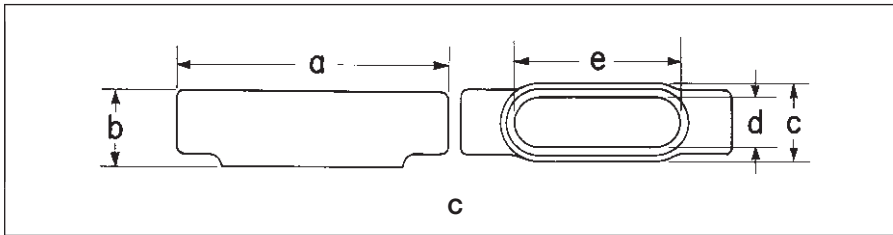

Form 7 C

Size	1/2	3/4	1	1 1/4	1 1/2	2	2 1/2	3
a	5 3/8	6	7	7 7/16	8 3/16	9 3/16	12	11 3/4
b	1 3/8	1 5/8	1 7/8	2 5/16	2 9/16	3 1/8	3 5/8	4 3/8
c	1 3/8	1 9/16	1 3/4	2 3/16	2 7/16	3	4 1/4	4 1/4
d	1 5/16	1 1/8	1 3/8	1 3/4	1 15/16	2 7/16	3 9/16	3 9/16
e	3 3/16	3 13/16	4 1/2	5	5 7/16	6 3/8	8 3/8	8 3/8

Form 8 C

Size	1/2	3/4	1	1 1/4	1 1/2	2	2 1/2	3
a	5 11/16	6 3/32	7 5/16	8 1/2	10 3/8	12 1/4	15 5/8	15 5/8
b	1 7/16	1 11/16	1 15/16	2 3/8	2 25/32	3 3/16	4 7/16	4 13/16
c	1 3/8	1 3/16	1 3/4	2 3/16	2 3/4	3 3/4	5	5
d	1	1 1/16	1 3/8	1 3/4	2 1/8	3	4 1/4	4 1/4
e	3 5/16	3 15/16	4 9/16	5 5/16	6 1/2	8 1/16	10 7/8	10 7/8

Mark 9 C

Size	1/2	3/4	1	1 1/4	1 1/2	2	2 1/2	3	3 1/2	4
a	5	5 11/16	6 19/32	7 1/2	8 1/4	10 1/2	15 5/8	15 5/8	18 3/4	18 3/4
b	1 3/8	1 5/8	1 7/8	2 1/2	2 3/4	3 7/16	4 7/16	4 13/16	5 11/16	5 15/16
c	1 3/8	1 1/16	1 3/4	2 3/16	2 1/2	3 3/16	5	5	6 1/4	6 1/4
d	1 3/16	1 3/8	1 1/2	1 15/16	2 1/4	2 7/8	4 1/4	4 1/4	5 7/16	5 7/16
e	3 5/16	3 15/16	4 9/16	5 5/16	6	8 7/16	10 7/8	10 7/8	13 7/16	13 7/16

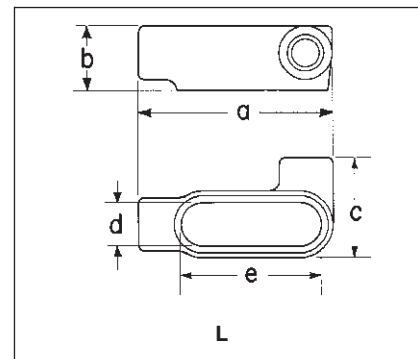
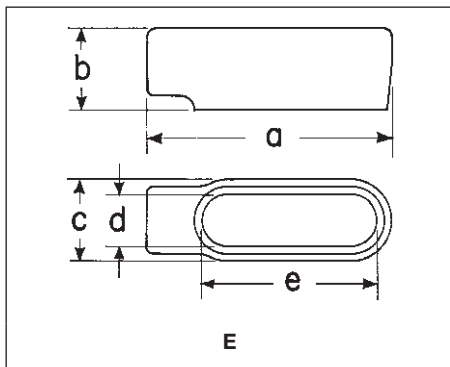

Form 7 E

Size	1/2	3/4	1
a	4 9/16	5 3/16	6
b	1 3/8	1 5/8	1 7/8
c	1 3/8	1 9/16	1 3/4
d	1 5/16	1 1/8	1 3/8
e	3 3/16	3 13/16	4 1/2

Form 7 L

Size	1/2	3/4	1	1 1/4	1 1/2	2
a	4 9/16	5 3/16	6	6 1/2	7 1/8	3 3/8
b	1 3/8	1 5/8	1 7/8	2 5/16	2 9/16	3 1/8
c	2 1/4	2 7/16	2 3/4	3 3/16	3 9/16	4 1/8
d	1 5/16	1 1/8	1 3/8	1 3/4	1 15/16	2 7/16
e	3 3/16	3 13/16	4 1/2	5	5 7/16	6 3/8

Condulet® Conduit Bodies - Cast Iron or Aluminum

1F

Dimensions (In Inches)

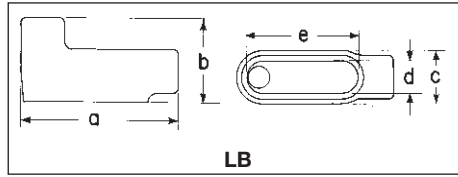

Form 7 LB

Size	1/2	3/4	1	1 1/4	1 1/2	2	2 1/2	3	3 1/2	4
a	4 ⁹ / ₁₆	5 ³ / ₁₆	6	6 ¹ / ₂	7 ¹ / ₈	8 ¹ / ₈	10 ¹ / ₂	10 ¹ / ₂	12 ¹¹ / ₁₆	12 ¹ / ₁₆
b	2 ¹ / ₄	2 ¹ / ₂	2 ⁷ / ₈	3 ³ / ₁₆	3 ¹ / ₁₆	4 ¹ / ₄	5 ¹ / ₈	5 ⁷ / ₈	6 ⁹ / ₁₆	7 ¹ / ₁₆
c	1 ³ / ₈	1 ⁹ / ₁₆	1 ³ / ₄	2 ³ / ₁₆	2 ⁷ / ₁₆	3	4 ¹ / ₄	4 ¹ / ₄	5 ¹ / ₄	5 ¹ / ₄
d	1 ⁵ / ₁₆	1 ¹ / ₈	1 ³ / ₈	1 ³ / ₄	1 ¹⁵ / ₁₆	2 ⁷ / ₁₆	3 ⁹ / ₁₆	3 ⁹ / ₁₆	4 ¹ / ₂	4 ¹ / ₂
e	3 ³ / ₁₆	3 ¹³ / ₁₆	4 ¹ / ₂	5	5 ¹ / ₁₆	6 ³ / ₈	8 ³ / ₈	8 ³ / ₈	10 ¹ / ₄	10 ¹ / ₄

Form 8 LB

Size	1/2	3/4	1	1 1/4	1 1/2	2	2 1/2	3	3 1/2	4
a	4 ¹⁵ / ₁₆	5 ⁹ / ₁₆	6 ¹⁵ / ₃₂	7 ¹⁷ / ₃₂	9 ¹ / ₈	11	13 ¹⁵ / ₁₆	13 ¹⁵ / ₁₆	16 ⁷ / ₈	16 ⁷ / ₈
b	2 ⁷ / ₃₂	2 ⁷ / ₁₆	2 ¹³ / ₁₆	3 ¹¹ / ₃₂	4 ¹ / ₃₂	4 ¹³ / ₁₆	6 ¹ / ₈	6 ¹ / ₂	7 ⁹ / ₁₆	7 ¹³ / ₁₆
c	1 ³ / ₈	1 ⁹ / ₁₆	1 ³ / ₄	2 ³ / ₁₆	2 ³ / ₄	3 ³ / ₄	5	5	6 ¹ / ₄	6 ¹ / ₄
d	1	1 ³ / ₁₆	1 ³ / ₈	1 ³ / ₄	2 ¹ / ₈	3	4 ¹ / ₄	4 ¹ / ₄	5 ⁷ / ₁₆	5 ⁷ / ₁₆
e	3 ⁵ / ₁₆	3 ¹⁵ / ₁₆	4 ⁹ / ₁₆	5 ⁵ / ₁₆	6 ¹ / ₂	8 ⁹ / ₁₆	10 ⁷ / ₈	10 ⁷ / ₈	13 ⁷ / ₁₆	13 ⁷ / ₁₆

Mark 9 LB

Size	1/2	3/4	1	1 1/4	1 1/2	2	2 1/2	3	3 1/2	4
a	4 ¹⁹ / ₃₂	5 ¹ / ₄	6 ³ / ₃₂	7 ¹ / ₃₂	7 ³ / ₄	10 ¹ / ₃₂	13 ¹⁵ / ₁₆	13 ¹⁵ / ₁₆	16 ⁷ / ₈	16 ⁷ / ₈
b	2 ¹ / ₈	2 ¹³ / ₃₂	2 ²⁷ / ₃₂	3 ¹⁵ / ₃₂	3 ³ / ₄	4 ¹⁹ / ₃₂	6 ¹ / ₈	6 ¹ / ₂	7 ⁹ / ₁₆	7 ¹³ / ₁₆
c	1 ³ / ₈	1 ⁹ / ₁₆	1 ³ / ₄	2 ³ / ₁₆	2 ¹ / ₂	3 ³ / ₁₆	5	5	6 ¹ / ₄	6 ¹ / ₄
d	1 ³ / ₁₆	1 ³ / ₈	1 ¹ / ₂	1 ¹⁵ / ₁₆	2 ¹ / ₄	2 ⁷ / ₈	4 ¹ / ₄	4 ¹ / ₄	5 ⁷ / ₁₆	5 ⁷ / ₁₆
e	3 ⁵ / ₁₆	3 ¹⁵ / ₁₆	4 ⁹ / ₁₆	5 ⁵ / ₁₆	6	8 ¹ / ₁₆	10 ⁷ / ₈	10 ⁷ / ₈	13 ⁷ / ₁₆	13 ⁷ / ₁₆



Form 7 LL & LR

Size	1/2	3/4	1	1 1/4	1 1/2	2	2 1/2	3	3 1/2	4
a	4 ⁹ / ₁₆	5 ³ / ₁₆	6	6 ¹ / ₂	7 ¹ / ₈	8 ¹ / ₈	10 ¹ / ₂	10 ¹ / ₂	12 ¹¹ / ₁₆	12 ¹ / ₁₆
b	1 ³ / ₈	1 ⁵ / ₈	1 ⁷ / ₈	2 ³ / ₁₆	2 ⁹ / ₁₆	3 ³ / ₈	3 ⁵ / ₈	4 ³ / ₈	4 ⁷ / ₈	5 ³ / ₈
c	2 ¹ / ₄	2 ⁷ / ₁₆	2 ³ / ₄	3 ³ / ₁₆	3 ⁹ / ₁₆	4 ¹ / ₈	5 ¹ / ₄	5 ³ / ₄	6 ¹⁵ / ₁₆	6 ¹⁵ / ₁₆
d	1 ⁵ / ₁₆	1 ¹ / ₈	1 ³ / ₈	1 ³ / ₄	1 ¹⁵ / ₁₆	2 ⁷ / ₁₆	3 ⁹ / ₁₆	3 ⁹ / ₁₆	4 ¹ / ₂	4 ¹ / ₂
e	3 ³ / ₁₆	3 ¹³ / ₁₆	4 ¹ / ₂	5	5 ¹ / ₁₆	6 ³ / ₈	8 ³ / ₈	8 ³ / ₈	10 ¹ / ₄	10 ¹ / ₄

Form 8 LL & LR

Size	1/2	3/4	1	1 1/4	1 1/2	2	2 1/2	3
a	4 ¹⁵ / ₁₆	5 ⁹ / ₁₆	6 ¹⁵ / ₃₂	7 ¹⁷ / ₃₂	9 ¹ / ₈	11	13 ¹⁵ / ₁₆	13 ¹⁵ / ₁₆
b	1 ⁷ / ₁₆	1 ¹¹ / ₁₆	1 ¹⁵ / ₁₆	2 ¹ / ₈	2 ⁵ / ₈	2 ²⁵ / ₃₂	3 ⁹ / ₁₆	4 ⁷ / ₁₆
c	2 ⁵ / ₃₂	2 ⁵ / ₁₆	2 ⁵ / ₈	3 ⁵ / ₃₂	4	5	6 ¹ / ₁₆	6 ¹¹ / ₁₆
d	1	1 ³ / ₁₆	1 ³ / ₈	1 ³ / ₄	2 ¹ / ₈	3	4 ¹ / ₄	4 ¹ / ₄
e	3 ⁵ / ₁₆	3 ¹⁵ / ₁₆	4 ⁹ / ₁₆	5 ⁵ / ₁₆	6 ¹ / ₂	8 ⁹ / ₁₆	10 ⁷ / ₈	10 ⁷ / ₈

Mark 9 LL & LR

Size	1/2	3/4	1	1 1/4	1 1/2	2	2 1/2	3	3 1/2	4
a	4 ¹⁹ / ₃₂	5 ¹ / ₄	6 ³ / ₃₂	7 ¹ / ₃₂	7 ³ / ₄	10 ¹ / ₃₂	13 ¹⁵ / ₁₆	13 ¹⁵ / ₁₆	16 ⁷ / ₈	16 ⁷ / ₈
b	1 ³ / ₈	1 ⁵ / ₈	1 ⁷ / ₈	2 ¹ / ₂	2 ¹ / ₄	3 ¹ / ₁₆	4 ⁷ / ₁₆	4 ¹³ / ₁₆	5 ¹¹ / ₁₆	5 ¹⁵ / ₁₆
c	2 ¹ / ₈	2 ³ / ₈	2 ⁵ / ₈	3 ¹ / ₈	3 ³ / ₁₆	4 ¹ / ₈	6 ¹¹ / ₁₆	6 ¹¹ / ₁₆	8 ³ / ₈	8 ³ / ₈
d	1 ³ / ₁₆	1 ³ / ₈	1 ¹ / ₂	1 ¹⁵ / ₁₆	2 ¹ / ₄	2 ⁷ / ₈	4 ¹ / ₄	4 ¹ / ₄	5 ⁷ / ₁₆	5 ⁷ / ₁₆
e	3 ⁵ / ₁₆	3 ¹⁵ / ₁₆	4 ⁹ / ₁₆	5 ⁵ / ₁₆	6	8 ¹ / ₁₆	10 ⁷ / ₈	10 ⁷ / ₈	13 ⁷ / ₁₆	13 ⁷ / ₁₆

Condulet® Conduit Bodies - Cast Iron or Aluminum

Dimensions (In Inches)

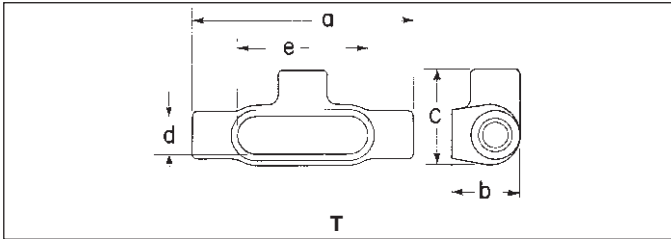

Form 7T

Size	a	b	c	d	e
1/2	5/8	1 3/4	2 7/16	1 5/16	3 3/16
3/4	6 1/4	2	2 5/8	1 1/8	3 13/16
1	7 1/4	2 1/4	3	1 3/8	4 1/2
1 1/4	7 7/16	2 5/16	3 3/16	1 3/4	5
1 1/2	8 3/16	2 9/16	3 9/16	1 15/16	5 7/16
2	9 3/16	3 1/8	4 1/8	2 7/16	6 3/8
2 1/2	12	3 5/8	5 3/4	3 9/16	8 3/8
3	12 7/16	4 3/8	5 3/4	3 9/16	8 3/8
3 1/2	14 5/16	4 7/8	6 15/16	4 1/2	10 1/4
4	14 5/16	5 3/8	6 15/16	4 1/2	10 1/4

Form 8T

1/2	5 11/16	1 3/4	2 5/32	1	3 5/16
3/4	6 9/32	2	2 5/16	1 3/16	3 15/16
1	7 5/16	2 1/4	2 5/8	1 3/8	4 9/16
1 1/4	8 1/2	2 5/8	3 5/32	1 3/4	5 5/16
1 1/2	10 3/8	2 25/32	4	2 1/8	6 1/2
2	12 1/4	3 9/16	5	3	8 9/16
2 1/2	15 5/8	4 7/16	6 11/16	4 1/4	10 7/8
3	15 5/8	4 13/16	6 11/16	4 1/4	10 7/8

Mark 9T

1/2	5	1 3/8	2 1/8	1 3/16	3 5/16
3/4	5 11/16	1 5/8	2 3/8	1 3/8	3 15/16
1	6 9/32	1 7/8	2 5/8	1 1/2	4 9/16
1 1/4	7 1/2	2 1/2	3 3/32	1 15/16	5 5/16
1 1/2	8 1/4	2 3/4	3 7/16	2 1/4	6
2	10 1/2	3 7/16	4 7/8	2 7/8	8 1/16
2 1/2	15 5/8	4 7/16	6 11/16	4 1/4	10 7/8
3	15 5/8	4 13/16	6 11/16	4 1/4	10 7/8
3 1/2	18 3/4	5 11/16	8 7/8	5 7/16	13 7/16
4	18 3/4	5 15/16	8 7/8	5 7/16	13 7/16

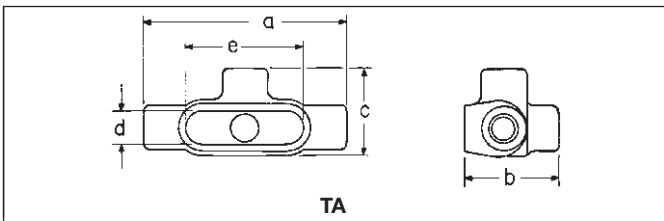

Form 7TA

Size	a	b	c	d	e
1/2	5 5/8	2 5/8	2 7/16	1 5/16	3 3/16
3/4	6 1/4	2 7/8	2 5/8	1 1/8	3 13/16
1	7 1/4	3 1/4	3	1 3/8	4 1/2
1 1/4	7 7/16	3 9/16	3 3/16	1 3/4	5
1 1/2	8 3/16	3 11/16	3 9/16	1 15/16	5 7/16
2	9 3/16	4 1/4	4 1/8	2 7/16	6 3/8

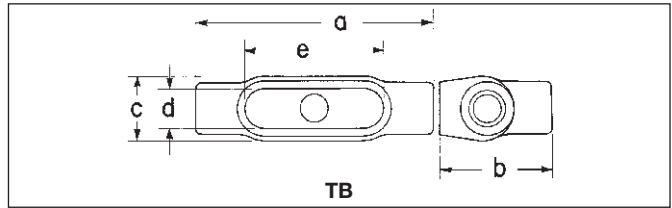

Form 7TB

Size	a	b	c	d	e
1/2	5 5/8	2 5/8	1 9/16	1 5/16	3 3/16
3/4	6 1/4	2 7/8	1 3/4	1 1/8	3 13/16
1	7 1/4	3 1/4	2	1 3/8	4 1/2
1 1/4	7 7/16	3 5/16	2 3/16	1 3/4	5
1 1/2	8 3/16	5	2 7/16	1 15/16	5 7/16
2	9 3/16	6 1/8	3	2 7/16	6 3/8

Form 8TB

1/2	5 11/16	2 17/32	1 3/8	1	3 5/16
3/4	6 9/32	2 3/4	1 9/16	1 3/16	3 15/16
1	7 5/16	3 1/8	1 3/4	1 3/8	4 9/16
1 1/4	8 1/2	3 11/32	2 2/16	1 3/4	5 5/16
1 1/2	10 3/8	4 1/32	2 3/4	2 1/8	6 1/2
2	12 1/4	4 13/16	3 3/4	3	8 9/16

Mark 9TB

1/2	5	2 1/8	1 3/8	1 3/16	3 5/16
3/4	5 11/16	2 13/32	1 9/16	1 3/8	3 15/16
1	6 9/32	2 27/32	1 3/4	1 1/2	4 9/16
1 1/4	7 1/2	3 15/32	2 3/16	1 15/16	5 5/16
1 1/2	8 11/32	3 7/8	2 1/2	2 5/32	5 7/8
2	10 5/8	4 19/32	3 3/32	2 13/16	8 3/32

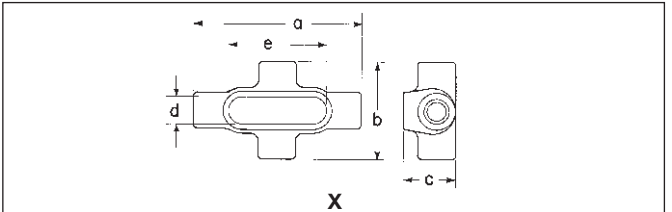

Form 7X

Size	a	b	c	d	e
1/2	5 5/8	3 5/16	1 3/4	1 5/16	3 3/16
3/4	6 1/4	3 1/2	2	1 1/8	3 13/16
1	7 1/4	4	2 1/4	1 3/8	4 1/2
1 1/4	7 7/16	4 1/8	2 5/16	1 3/4	5
1 1/2	8 3/16	4 5/8	2 9/16	1 15/16	5 7/16
2	9 3/16	5 3/16	3 1/8	2 7/16	6 3/8

Form 8X

1/2	5 11/16	2 29/32	1 3/4	1	3 5/16
3/4	6 9/32	3 1/16	2	1 3/16	3 15/16
1	7 5/16	3 1/2	2 1/4	1 3/8	4 9/16
1 1/4	8 1/2	4 1/8	2 5/8	1 3/4	5 5/16
1 1/2	10 3/8	5 1/4	2 15/32	2 1/8	6 1/2
2	12 1/4	6 1/4	3 9/16	3	8 9/16

Mark 9X

1/2	5 11/16	2 29/32	1 3/4	1	3 5/16
3/4	6 9/32	3 1/16	2	1 3/16	3 15/16
1	7 5/16	3 1/2	2 1/4	1 3/8	4 9/16